

TRANSFORMER

TR100VA001

Transformer 96 VA, 120 to 24 Vac, Circuit Breaker, Foot and Single Threaded Hub Mount

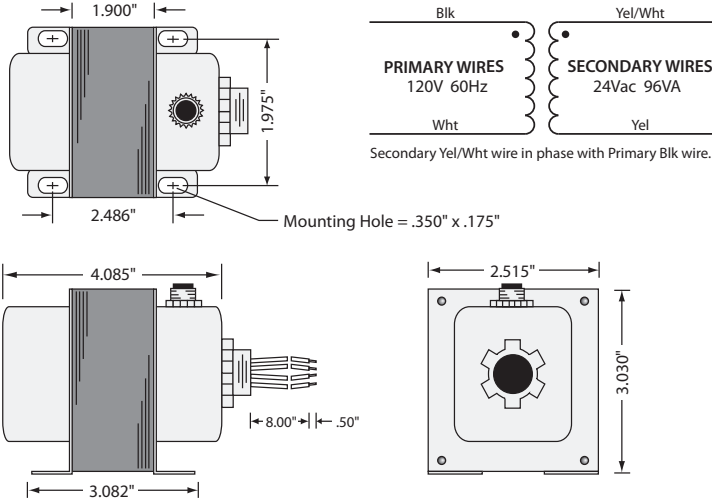

SPECIFICATIONS

VA Rating: 96
Frequency: 50/60 Hz
Mounting: Foot & Single Threaded Hub
Over Current Protection: Circuit Breaker
Operating Temperature: -30 to 140° F

Dimensions: 4.085" x 2.515" x 3.030" (w/ .500" NPT Hub)
Wire Length: 8.0" Typical w/ .5" Strip
MTBF: 100,000 Hours @ 77° F
Construction: Split-Bobbin
Approvals: Class 2 UL5085-3 Listed, C-UL, CE, RoHS